

Dynamic Simulation and Start-up Scenario a Pilot Distillation Column for Separating C6-C8 Hydrocarbons

Kunthaleeporn Kerddonfak, Thongchai Rohitathisa Srinophakun*

Department of Chemical Engineering, Faculty of Engineering, Kasetsart University, Bangkok, Thailand

Suthipong Laikitmongkol

Department of Chemical Engineering, Faculty of Engineering, King Mongkut's University of Technology Thonburi, Bangkok, Thailand

* Corresponding author. E-mail: fengtcs@hotmail.com

Received: 4 June 2014; Accepted: 24 November 2014; Published online: 19 December 2014

© 2015 King Mongkut's University of Technology North Bangkok. All Rights Reserved.

Abstract

A pilot distillation column was fabricated for multipurpose functions, such as separation testing compared with a real plant distillation column, and sample preparation for other projects. The packing efficiency of this column was developed by changing the packing material. Packing efficiency is normally an important key index, especially after a revamp. Aspen Dynamic was used to generate the best procedure for the start-up operation, covering three variables: the distillate rate, the reflux rate and the bottom rate. The start-up procedure according to these three parameters was divided into six scenarios. In addition, the effect of reflux rate and feed location was the operating conditions, including temperature profile of the column, benzene concentration in the overhead stream, and liquid levels in the reflux drum and sump. The test run data matched well, with 0.6 Murphree efficiency. The optimal procedure for the start-up operation was found to be a distillate rate – bottom rate – reflux rate scenario, which took just 9 h to reach a steady state.

Keywords: *Aspen Plus, Aspen Dynamic, Start-up procedure, Murphree efficiency, Steady state*

1 Introduction

A distillation column is one of the most commonly used pieces of equipment in thermal separation, and has been used for centuries. It is necessary for the olefin plant to separate the components of interest, such as ethylene and propylene, from other ones. Moreover, it is used to recover useful components from waste and by-product streams which occur from the olefin process. Wesselingh proposed non-equilibrium models for a distillation column [1]. A recent study on the separation of C8–C14 hydrocarbons in a laboratory packing distillation column focused on the development of steady-state models for achieving packing efficiency of

a pilot distillation column [2]. Another study proposed the concept of high separation efficiency and column capacity obtained in olefin paraffin distillation using hollow fiber structured packings (HFSPs) [3]. The studies about methods and systems for controlling the pressure of distillation columns that those operating under vacuum pressure and conventionally equipped with a steam ejector system for purified C6–C8 aromatic hydrocarbons from a hydrocarbon feed stream [4]. Other study disclosed the relationship relating to a process for refining a hydrocarbon feed to make substantially styrene-free C6–C8 aromatic hydrocarbons (BTX) [5]. Not only previous steady state studies but also many studies proposed about

Please cite this article as: K. Kerddonfak, T.R. Srinophakun, and S. Laikitmongkol, "Dynamic Simulation and Start-up Scenario a Pilot Distillation Column for Separating C6-C8 Hydrocarbons," *KMUTNB Int J Appl Sci Technol*, Vol.8, No.1, pp. 77-85, Jan.-Mar. 2015, <http://dx.doi.org/10.14416/j.ijast.2014.11.002>

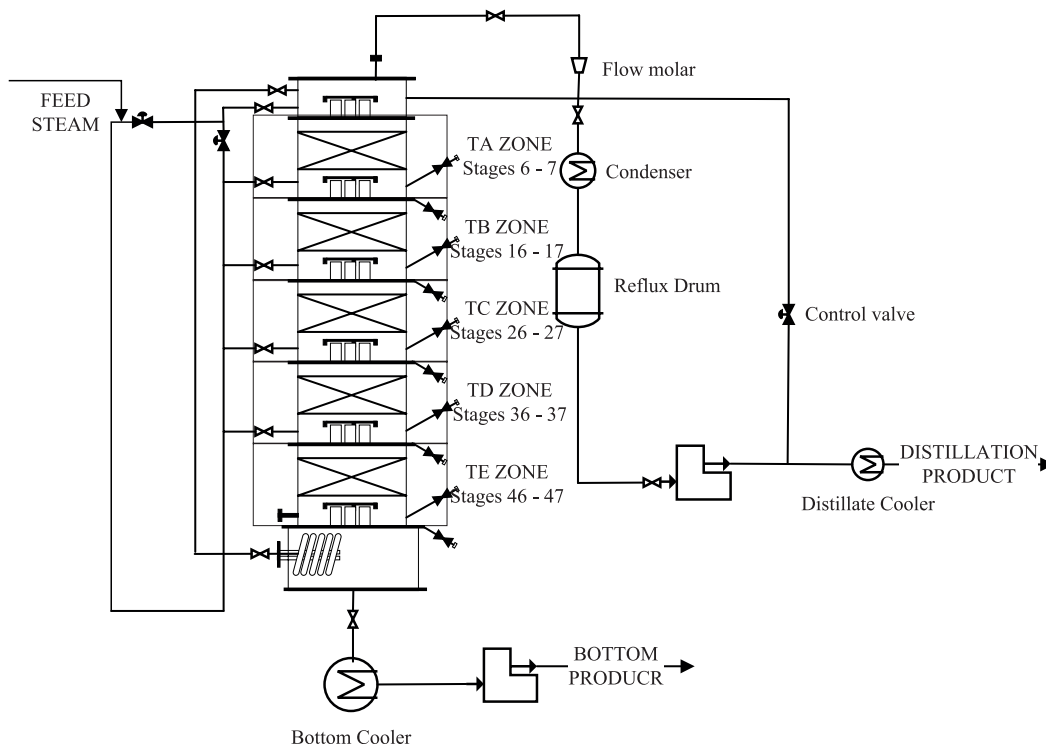

Figure 1: Schematic diagram of the pilot plant distillation column used for the separation.

control and optimization of olefin column. For instance, the study of optimization algorithms to estimate the optimum operating parameters required for the achievement of high purities of the top and the bottom products using olefin metathesis process occurring in a reactive packed distillation column [6]. Therefore, this article will study the packing efficiency of a pilot distillation column, and the start-up procedures in order to obtain the best operation to under the steady state process.

2 Procedure

2.1 Process description and problem statement

The pilot distillation column was designed to test separation and prepare sample for for n-hexane and Isopar projects. Its schematic and list of unit are shown in Figure 1. The feed stream (FEED) which consists of benzene and toluene mixture was introduced to the column above the packed section. This system was used to study the separation of benzene in the overhead

stream (OVHD) from the mixture of benzene-toluene. The pilot distillation column was represented by RADFRAC model in Aspen Plus.

From the actual configurations of the pilot distillation column, there were heater that submerges at the bottom of the column as a heat source, and the Sulzer packing which arranges along the column as a contactor to enhance the separation efficiency of the column. In addition, the reflux was cooled from the condenser to subcooled media. However, the RADFRAC model in this simulation used a reboiler as a heat source and the plate column instead of a heater and a packing, respectively. One of the important data that simulation model requires is the number of stages was but the actual configuration of pilot distillation column was packed by Sulzer packing. Therefore, it is important to convert the height equivalent to a theoretical stage (HETP) or the packing to the number of the theoretical stage.

The necessary data which were required for the Aspen Plus simulation was divided into two main parts, namely stream data and equipment data shown in Table 1.

Table 1: The required stream input data of the pilot distillation column

Parameter	Feed
Temperature (°C)	30
Pressure (atm)	1.036
Total flow (kg/hr)	1.724
Mass fraction	
- Benzene	0.503
- Toluene	0.497
Number of stages	52
Distillate rate (kg/hr)	0.9
Reflux rate (kg/hr)	6.465
Feed stages	27
Condenser pressure (atm)	1
Column pressure drop (atm)	0.07
Subcooled reflux temperature (°C)	30

3 Result and Discussion

The steady state model developed can describe the process behavior at normal operation while the dynamic model created from Aspen Dynamics was generated for observing the response of the output parameters before the steady-state condition. Therefore, the dynamic model was also used for investigating the start-up procedure of pilot distillation column operation as mentioned. The model tuning can give the Murphree efficiency of all packing at 1 except the Murphree efficiency of packing A (stages 2–11) which was only 0.6.

In this work, the dynamic responses were found of interest in terms of the temperature profile of the column (A–E), level in the reflux drum and sump, and the mass fraction of benzene in the overhead stream (Xbz) under feed location and reflux rate give in Table 2. The dynamic responses of the simulation model was verified with the responses from test run data.

Table 2: The three-step operation of the pilot distillation column

Operation	Feed location	Reflux rate (kg/h)	Time (h)
Base case	C	6.465	1.0–4.0
Step 1	D	6.465	4.0–6.3
Step 2	D	6.982	6.3–8.3

The dynamic responses were carried out in two steps, as shown in Table 3. The feed was fed at packing C with 6.465 kg/h of the reflux rate and then its location was changed to packing D while keeping the reflux rate constant in step 1. In step 2, the reflux rate

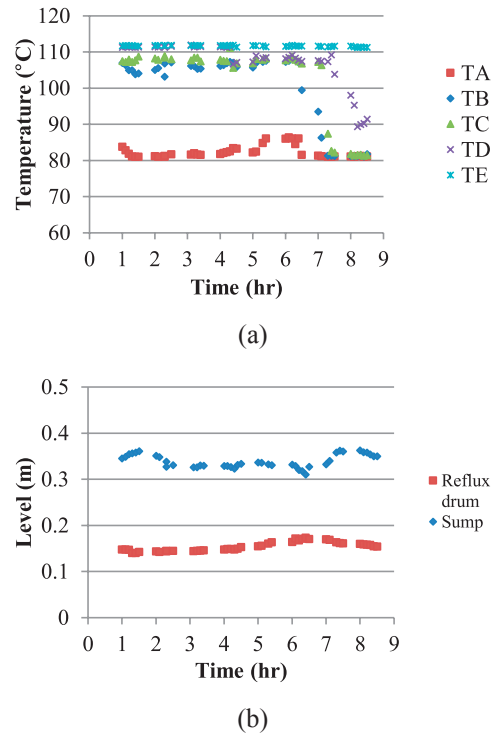

Figure 2: Dynamic responses: (a) temperature profile of the column; (b) levels in reflux drum and sump.

was increased from 6.465 kg/h to 6.982 kg/h (reflux ratio from 7.183 to 7.758) by keeping the feed location at location D. Moreover, the time which each step took is also shown in Table 3.

Table 3: The percentage difference of parameters between the test run data and simulation results

Parameter	Average (test run)	Average (simulation)	Percentage difference
TA (°C)	81.92	83.44	1.86
TB (°C)	107.45	107.45	0.00
TC (°C)	108.06	108.06	0.00
TD (°C)	111.18	111.18	0.00
TE (°C)	112.81	112.81	0.00
Reflux drum level (m)	0.146	0.146	0.19
Sump level (m)	0.338	0.340	0.73

The considered output parameters are the temperature profile of the column (A–E) and level in reflux drum and sump were observed from the pilot plant’s test run data as shown in Figure 2.

According to the temperature profile of the column (A–E) from the simulation results owing to

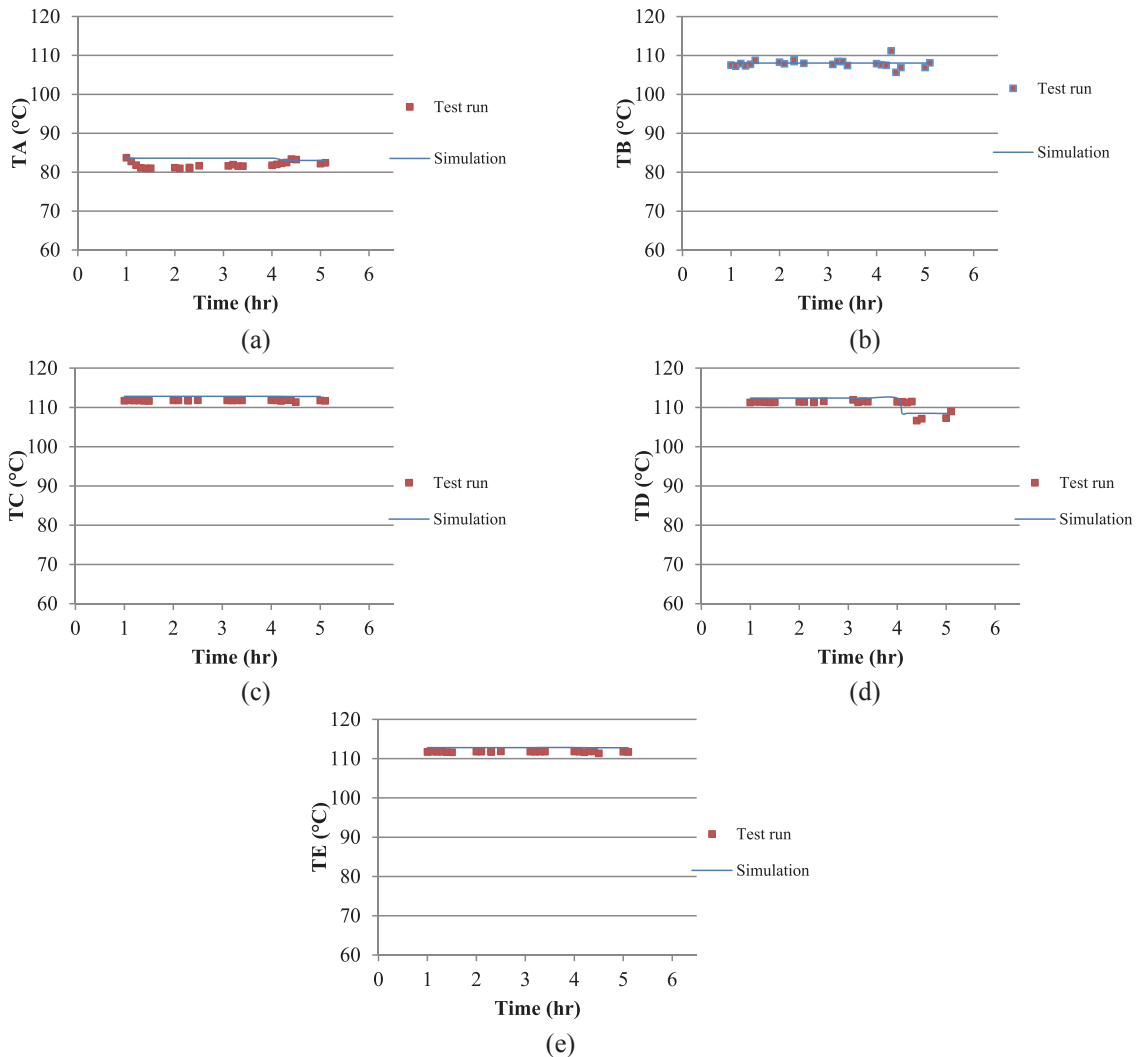

Figure 3: Comparison between test run data and simulation results of packing temperatures A, B, C, D, E (TA, TB, TC, TD, TE) under a change of feed condition.

changing the feed location from packing C to D, the trend of temperature profile of the column (A–E) was found to be quite similar with the test run data. When the reflux rate was varied from 6.465 to 6.982 kg/h around 8% at 6.3 h, the temperature profile of the column (A–E) is suddenly dropped more than the test run data. However, the trend of the temperature profile (A–E) of the column was also similar with the test run data. In the same way, the trends of the reflux drum and sump level were found to be quite constant when these two steps were already changed. To ensure that the dynamic model was correct, the comparison of both

the temperature profile of the column (A–E) and the level of the reflux drum and sump between the test run data and dynamic model was separated in each graph in the section below.

3.1 Dynamic responses of feed location

The feed location was changed from packing A (stages 6–7) to packing D (stages 36–37). The response of the temperature profile of the column (A–E) when the feed location was changed from packing C to packing D are shown in Figure 3. After the feed location was

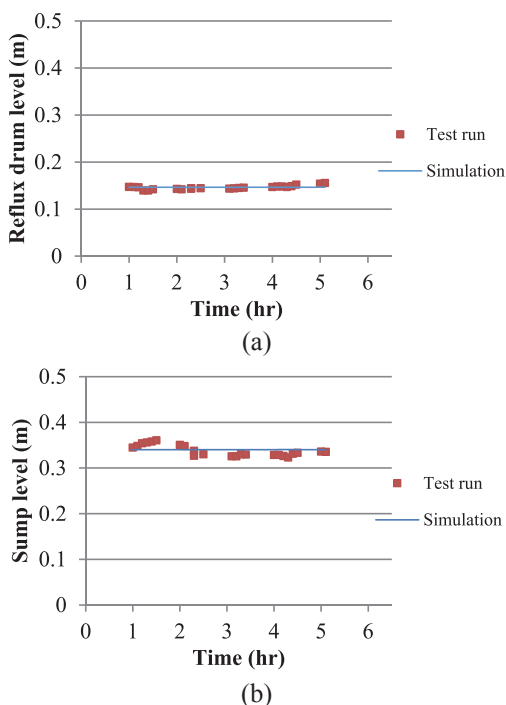

Figure 4: Comparison between test run data and simulation results of reflux drum level and sump level when the feed location is changed.

changed at 4 h, the temperature profile of the column (A–E) was constant except the packing D temperature. It obviously decreased because more liquid with the lower temperature was introduced into the packing D column.

The responses of the reflux drum and sump level are shown in Figure 4(a) and 4(b) respectively. Changing the feed location has slightly affected on the sump and reflux drum level. Furthermore, the sump level of the column is controlled by adjusting the temperature of the heater manually. Therefore, the liquid level in sump is also constant as same as the level in the reflux drum. However, the comparison of the test run data and simulation results must be performed. The difference percentage of each parameter between the simulation model and the pilot test run data must be less than 5% as the acceptable value.

3.2 Dynamic responses of reflux rate

The dynamic responses of the process under the reflux rate was increased from 6.47 to 6.98 kg/h or

increased around 8% are shown below. The responses of the temperature profile of the column (A–E) after the reflux rate increased from 6.47 to 6.982 kg/h are shown in Figure 5. The results show that the trend of the temperature profile of the column (A–E) from the simulation model was closed to the test run data except the temperature profile of packing D. At 6.5 h, trends of the temperature profile of the column (A–E) become lower than the previous condition because there was more flow of liquid refluxed into the column.

Normally, as the reflux rate was changed, the actual process was supposed to respond with time delay depending on the location of the packing temperature. The temperature at the top of the columns (TA) shows faster response than the other temperatures as shown in the test run data of each packing temperature. However, this dynamic model was generated with no the time delay controller to control the process of the pilot distillation column. Consequently, the trend of the temperature profile of the column from the dynamic model was not the same as the test run data especially the temperature of the packing D. From Figure 5(d), the packing D temperature from the dynamic model was suddenly decreased, which was different from the test run data due to the effect of the time delay controller.

Furthermore, trend of the temperature of all packs decreased to the new steady state except the packing E temperature. The packing E temperature (TE) was measured at the lower packing of the pilot distillation column. The temperature at the bottom of the column was higher than that of the top of the column. Most of benzene component was vaporized before entering to the packing E. Therefore, this packing mostly consisted of toluene component as a major component. Thus, the packing E temperature was quite constant value at the normal boiling temperature of toluene.

The responses of the reflux drum and sump level are shown in Figure 6. Although, the reflux rate was introduced to the column, the sump level was controlled by adjusting the temperature of the heater manually. From the normal operation, the heat duty of the heater was around 1.04 kW. This value was increased due to increasing of the reflux rate in order to maintain the sump level. Similarly, the reflux drum level was also constant with the new heat duty. The percentage difference of each parameter between the simulation model and the pilot plant test run data was found to less than 5% as the acceptable value.

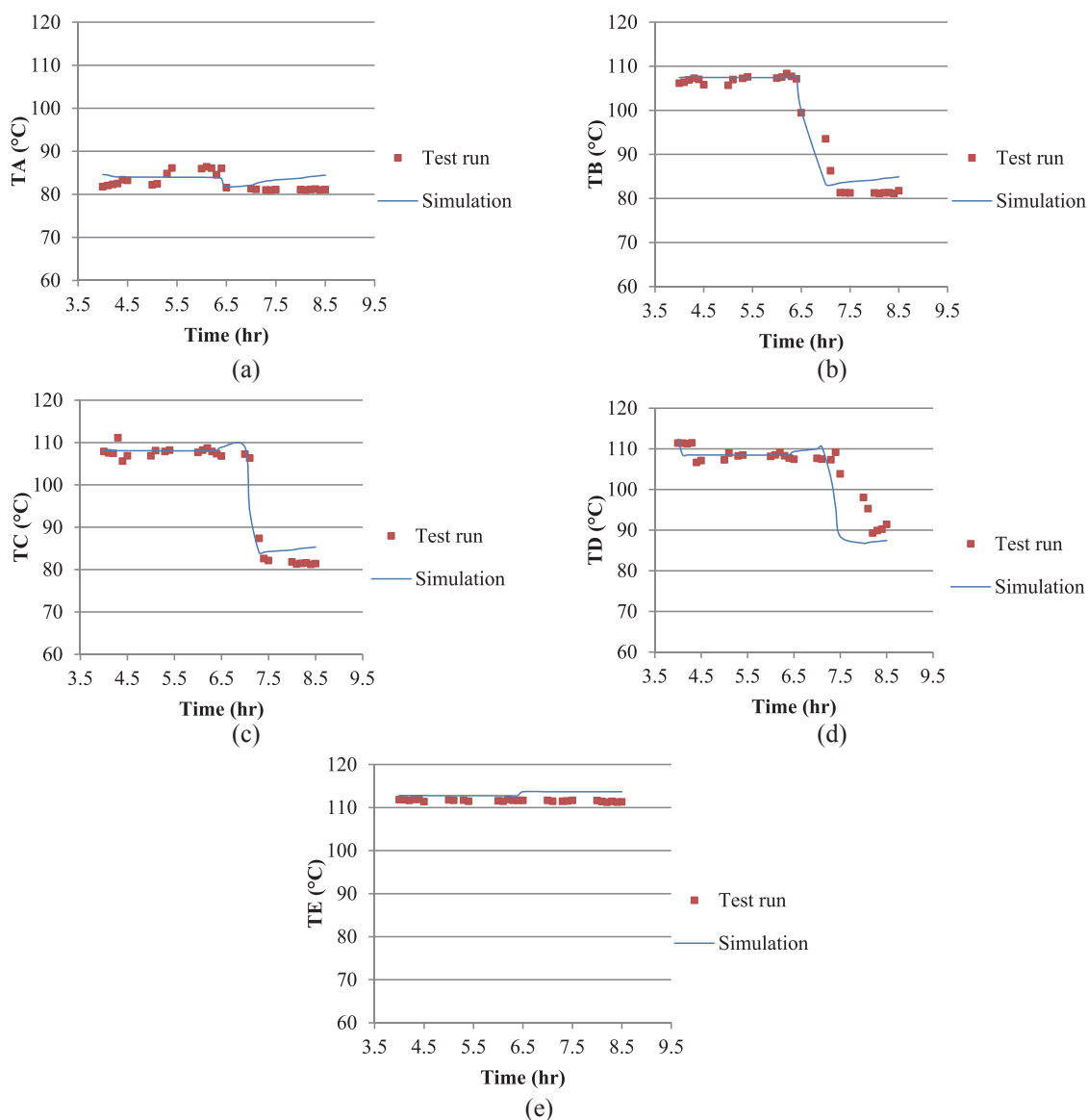

Figure 5: Comparison between test run data and simulation results of packing temperatures A, B, C, D, E (TA, TB, TC, TD, TE) at various reflux rates.

3.3 Start-up procedure

In the actual operation, the procedure for the start-up has not exactly the method and operated by the operator's experience. After the reflux is totally introduced to the column, the sequence for adjusting the parameters must be concerned. The start-up procedure concerns about adjusting the sequence of three parameters; the distillate rate, the reflux rate and the bottom rate. The

sequence of these parameters for the actual operation is adjusted these distillate, reflux and bottom rate, respectively. The purpose of the start-up procedure is to generate the best start-up operation which takes the shortest time to a steady state. The percentage difference of each parameter can be determined by the difference of the average value of test run data and the simulation model. From Table 4, all of these parameters have the percentage difference lower than

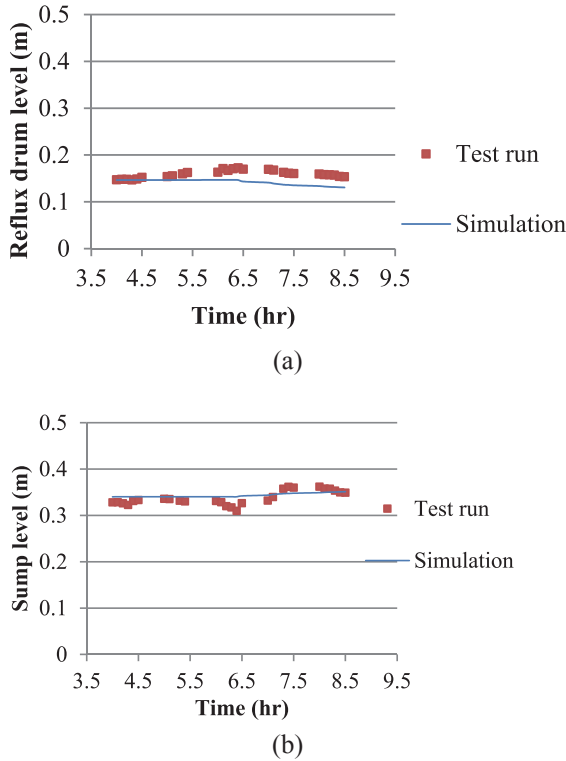

Figure 6: Comparison between test run data and simulation results of reflux drum level and sump level.

5%. Therefore, it can be concluded that the trend of dynamic model was also quite similar to the trend of the test run data when reflux rate was increased from 6.47 to 6.98 kg/hr. 6 scenarios were used for the start-up procedure as shown in Table 5. The target value of the distillate rate, the reflux rate and the bottom rate of each scenario are 0.9, 6.47 and 0.82, respectively

Table 4: The percentage difference of parameters between the test run data and simulation results when the reflux rate is increased

Parameter	Average (test run)	Average (simulation)	Percentage difference
TA (°C)	82.72	83.77	1.26
TB (°C)	96.89	97.65	0.79
TC (°C)	99.24	99.82	0.58
TD (°C)	104.88	102.60	2.17
TE (°C)	111.60	113.18	1.42
Reflux drum level (m)	0.144	0.142	1.78
Sump level (m)	0.338	0.344	1.71

Table 5: Case study for start-up operation

Scenario	Procedure
1	Distillate >> Reflux >> Bottom
2	Distillate >> Bottom >> Reflux
3	Bottom >> Distillate >> Reflux
4	Bottom >> Reflux >> Distillate
5	Reflux >> Distillate >> Bottom
6	Reflux >> Bottom >> Distillate

The main objective was to find the best scenario for the start-up procedure which would take the shortest time to reach a steady state. However, the comparison of each scenario occurred when the criteria was generated. This criterion used was the mass fraction of benzene in the overhead stream which was controlled at the range of 0.89-0.91.

From scenario 1, the adjustment sequence was the distillate rate, the reflux rate and the bottom rate, respectively. This scenario was the same as the actual start-up operation of pilot distillation column as shown in Figure 7(a). The column was heated gradually by the heater of the column from 0 to 2.5 h until the temperature profile of the column (A–E) reached a steady state. Then, the liquid from the reflux drum was totally flown to the column for about 0.5 h. Therefore, the temperature profile of the column (A–E) suddenly dropped in the second step. In the last step, the sequence of scenario 1 was performed from 3 to 4.5 h. From this step, it took 1.5 h for adjusting the three parameters which were the distillate rate, the reflux rate and the bottom rate. In this step, the temperature profile of the column (A–E) was adjusted to reach a steady state condition. Furthermore, the time to a steady state for scenario 1 was about 6.50 h, as shown by the dashed line.

The adjustment sequence was the distillate rate, the bottom rate and the reflux rate, respectively, in scenario 2. From Figure 7(b), the steps 1 and 2 were carried out to heat-up the column and flow totally reflux is also same as the scenario 1. The trend of the temperature profile of the column (A-E) for steps 1 and 2 was quite similar to that of the scenario 1. However, the adjustment of sequence of step 3 was changed from that of scenario 1 by the bottom rate before the reflux rate. The results from the simulation showed that the temperature profile of packing B and C was quite smoothly. Finally, this step just took 6 hours to reach a steady state.

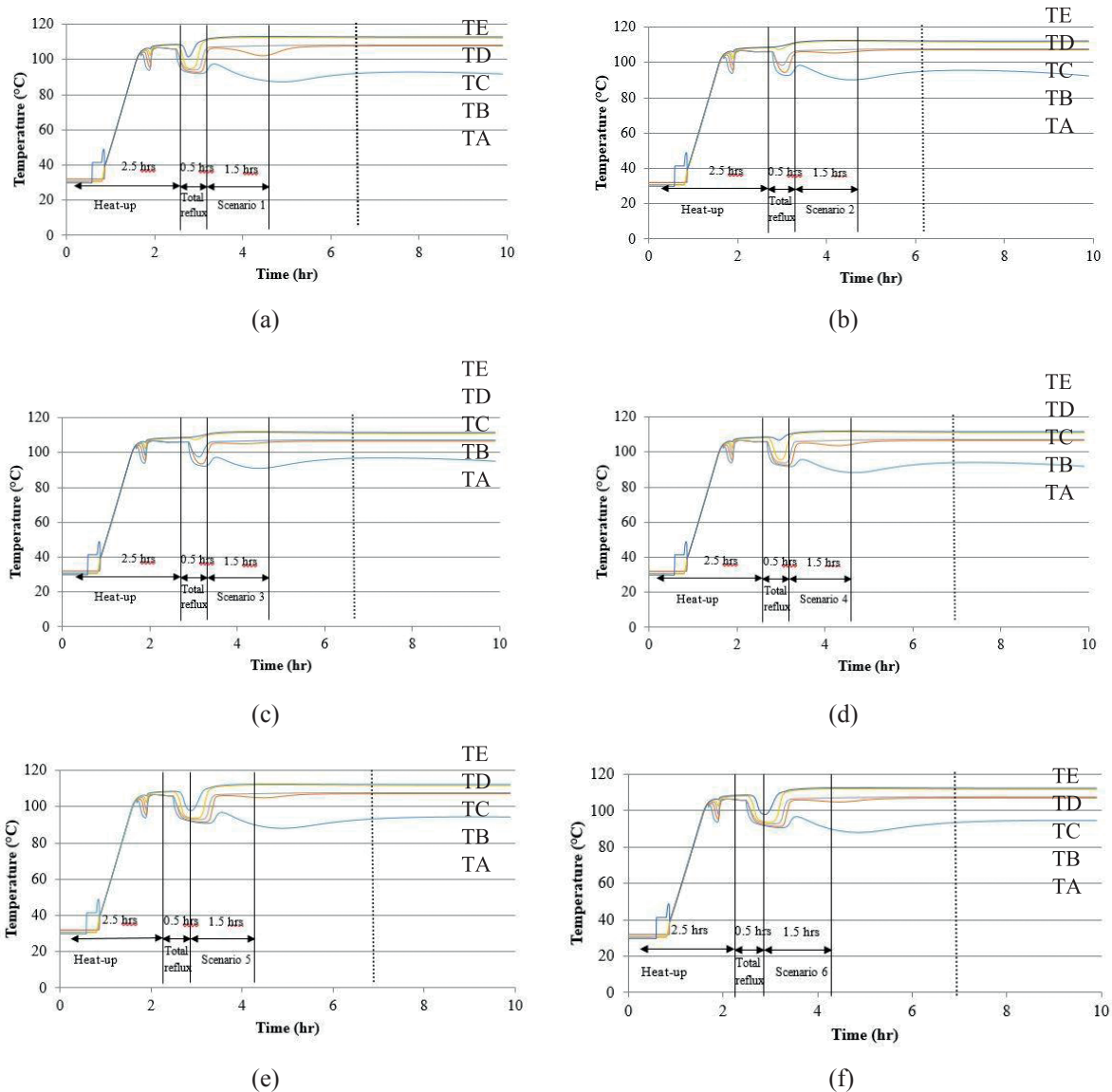

Figure 7: Temperature profile for the column (A–E) of scenarios 1-6.

In scenario 3, the adjustment sequence is the bottom rate, the distillate rate and the reflux rate, respectively. From Figure 7(c), the steps 1 and 2 which were heating up the column and passing total reflux were also same as that of scenarios 1 and 2. In this step, the bottom rate was adjusted firstly to 0.82 kg/h. Then, the distillate rate was adjusted to 0.9 kg/h. Finally, the reflux rate was also reduced from the total reflux to 6.47 kg/h. From this scenario, the time to reach a steady state was about 6.20 h, as shown by the dashed line.

Considering scenario 4, the adjustment of sequence was changed from the scenario 3 with the reflux rate being adjusted before the distillate rate. The trend of the temperature profile of the 3 steps were similar to that of scenario 3. In this scenario, it took 6.70 h of time to reach a steady state. See Figure 7(d), even though it took a longer time than scenario 3 but this scenario was able to obtain higher purity of benzene in the overhead stream as shown in the lower temperature of packing A.

Scenario 5 adjusted the reflux rate, the distillate rate and the bottom rate, respectively. The temperature profile is shown in Figure 7(e). The column was heated at the bottom in step 1 and then the reflux was totally passed in step 2. The trend of the temperature profile is still similar to the previous ones and took 7.40 h to reach a steady state.

The adjustment sequence was the reflux rate, the distillate rate and the bottom rate, respectively. The temperature profile of the column (A–E) is shown in Figure 7(f). The scenario 6 adjusted the bottom rate before distillate rate. The trend of the temperature profile of 3 steps was quite similar to those of the scenarios above. It took 7.40 h to reach a steady state.

Table 6: Conclusion of the start-up scenario

Scenario	1	2	3	4	5	6
Tss (h)	6.50	6.00	6.20	6.70	7.40	7.20
Xbz	0.905	0.90	0.890	0.905	0.907	0.907

The results of the start-up procedure are shown in Table 6. The six scenarios considered were simulated by considering the purity of benzene in the overhead stream as a constraint. This target was kept between 0.89 – 0.91 in order to compare the results of each scenario. The best scenario was selected by observing the time to reach a steady state. The best scenario for the pilot distillation column start-up procedure was scenario 2 because it took just about 6.00 hours to reach a steady state as shown in temperature profile along the column (A-E) in Figure 7(b).

4 Conclusions

A steady state model of a pilot plant distillation column was developed to find the packed efficiency of the column. Its model was based on the test run data of separation of benzene and toluene mixtures. The steady state model was matched with 50 theoretical stages and 0.6 Murphree efficiency of packing A. The differences in the purity of benzene in the overhead stream between the simulation results and the test run data was found to be less than 5%. As such, the difference of the temperature profile of the column between the simulation results and test run data were found to be less than 2°C. Therefore, the model was found to give a sufficiently accurate prediction in the

process operation.

Furthermore, a dynamic model of the column was developed to study the responses of feed location and reflux rate. The dynamic responses from the simulation model was discovered to have a trend of temperature profile of the column and the level of the sump and the reflux drum agreed with the values obtained from test run data. All of the differences between the dynamic model and the test run data were less than 5%.

The best scenario for the start-up operation is Distillate > Bottom > Reflux because of a shortest time to reach a steady state value of the purity of benzene in the overhead stream.

Acknowledgments

This research has been supported by: 1. Department of Chemical Engineering, Faculty of Engineering Kasetsart University; 2. Department of Chemical Engineering, Faculty of Engineering King Mongkut's University of Technology Thonburi.

References

- [1] J.A. Wesselingh, "Non-Equilibrium Modelling of Distillation," *Braz. J. ChERD.*, vol. 75, pp. 529-538, 1997.
- [2] A.E. Orlando Jr., L.C. Medina, M.F. Mendes, and E.M.A. Nicolaiewsky, "HETP evaluation of structured packing distillation column," *Braz. J. Chem. Eng.*, vol. 26, pp. 619-633, 2009.
- [3] D. Yang, L. Le, and R. Martinez, "Hollow fibers structured packings in olefin/paraffin distillation: apparatus scale-up and long-term stability," *Ind. Eng. Chem. Res.*, vol. 52, pp. 9165-9179, 2013.
- [4] B.R. Beadle, J.L. Noe, and S.A. Williams, "Distillation column pressure control," U.S. Patent 8 524 046, Sept. 3, 2013.
- [5] K.-Y. Wu, A.T. Lee, K.T.-T. Chuang, H.C. Shen, and T.-B. Lin, "Separating styrene from C6–C8 aromatic hydrocarbons," U.S. Patent 8 766 028, May 9, 2013.
- [6] A. Giwa and S.O. Giwa, "Estimating the optimum operating parameters of olefin metathesis reactive distillation process," *ARPJ. Eng. Appl. Sci.*, vol. 8, pp. 614-624, 2013.