

## **An Empirical Study on the Effect of Temperature and Irradiance on the Power Output of a Mini PV Plant in Ogun State, Nigeria**

Martins Osifeko\*

Department of Computer Engineering, Olabisi Onabanjo University, Ago-Iwoye

Ayodeji Okubanjo and Oluwadamilola Oyetola

Department of Electrical and Electronics Engineering, Olabisi Onabanjo University, Ago-Iwoye

Hezekiah Adeyemi

Department of Mechanical Engineering, Olabisi Onabanjo University, Ago-Iwoye

\* Corresponding author. E-mail: osifeko.martins@oouagoiwoye.edu.ng DOI: 10.14416/j.ijast.2018.06.006

Received: 5 March 2018; Accepted: 21 May 2018; Published online: 26 June 2018

© 2018 King Mongkut's University of Technology North Bangkok. All Rights Reserved.

### **Abstract**

In this paper, an empirical study on the effect of temperature and irradiance on solar cell parameters is done. To achieve this, a simulation model that describes the relationship between irradiance, temperature and power output is developed using MATLAB R2013b. A pyranometer and thermometer devices were then used to obtain irradiance and temperature data from a mini PV plant for a 30 day period. Power output from the plant were also captured during this period using the EP-Solar Charge Controller. The obtained irradiance and temperature data were then fed into the developed SIMULINK models. Power outputs from the models were compared with the measured power from the plant using three statistical test tools of MAPE, MBE, and RMSE.

**Keywords:** Solar irradiance, PV cell temperature, Empirical study, PV power output, PV cell modelling

### **1 Introduction**

Due to the negative impact of fossil fuel energy on the environment and its rising cost, the world is gradually moving towards sustainable renewable energy resources [1]. Sustainability and abundance of solar radiant energy are important factors that makes solar energy, a candidate of choice among the renewable energy sources [2]. Despite the intermittent nature of sunlight, solar energy is widely available and completely free of cost. Solar irradiance and temperature are the essential factors that affect the output characteristics of a solar cell. The open circuit voltage increases in logarithmic way with solar irradiation whereas the short circuit current increases linearly [3], [4]. The dominant effect

with increasing cell's temperature is the linear decrease of open circuit voltage, the cell is then subjected to less efficiency. The short circuit current slightly increases with temperature [5], [6].

Manufacturers of PV cells provide electrical parameters only at Standard Test Conditions (STC) which are irradiance = 1000 W/m<sup>2</sup>, 1.5 Air Mass (AM), and cell temperature of T<sub>cell</sub> = 25°C [7], [13]. However, it is a common knowledge that the operating conditions of the PV cells largely vary from the STCs described by the manufacturers. To solve this problem, analytical models are built to predict the performance of the PV system at any operating and weather condition. The model predicts the I–V characteristic of a PV system as a function of irradiance, angle of incidence of solar

Please cite this article as: M. Osifeko, A. Okubanjo, O. Oyetola, and H. Adeyemi, "An empirical study on the effect of temperature and irradiance on the power output of a mini PV plant in Ogun State, Nigeria," *KMUTNB Int J Appl Sci Technol*, vol. 11, no. 3, pp. 159–165, Jul.–Sep. 2018.

radiation, the spectrum of sunlight, and temperature [8]. It is tempting to accept these models as truly representative of the relationship between these parameters, however, the scarcity of empirical studies on the performance of these analytical models underscores the need for caution. It also drives the need for this study. This work aims to carry out an empirical study on the effect of temperature and Irradiance on the power output of a mini PV plant.

Several attempts have been made in the literature to study the effect of temperature and irradiance on solar cell parameters [9]–[13]. In [9], the impact of solar irradiance intensity and temperature on the performance of compensated crystalline silicon solar cells was carried out using only analytical models. Result from the study revealed that for the same rated output power, compensated crystalline silicon solar cells generate less electricity than the reference silicon solar cells at low irradiance intensity. The work done in [10] investigates the effect of temperature on the electrical parameters of a GaInP/GaAs tandem solar cell. To achieve this, the top GaInP and the bottom GaAs tandem cells were separately simulated using the one-dimensional solar simulator SCAPS-1D. The temperature dependency of the solar cell's parameters was then investigated in the temperature range from 25 to 80°C. The simulation results showed that voltage losses within the tandem cell are additive (Top cell and Bottom cell), while the short circuit current density depends smoothly on temperature, and the efficiency reduction is about (–0.038), (–0.035) and (–0.054 %/°C) for the bottom, top and tandem cells respectively.

In [11], the effect of cell temperature on the photovoltaic parameters of mono-crystalline silicon solar cell was carried out. The experiment was carried out employing solar cell simulator with varying cell temperature in the range 25–60°C at constant light intensities 215–515 W/m<sup>2</sup>. The results showed that cell temperature has a significant effect on the photovoltaic parameters and controls the quality and performance of the solar cell.

In [12], the influence of working temperature on a polysilicon module was investigated in Brunei Darussalam for a period of two years. Results from the study show that the rise in temperature produces thermal agitation that enhances the losses of free carriers in a polycrystalline module. Result further show that the efficiency and the output

power decreases with an increase in the working temperature.

Reviewed literature has shown that most study was done using only simulated models and does not validate the accuracy of these models. This creates the need for an empirical study that can be used to validate the accuracy of these models.

The aim of this paper is to carry out an empirical study on the effect of temperature and irradiance on a mini PV plant.

## 2 System Description

According to Perpiñan model [8], the DC output power of one module is related to the following parameters as described below:

$$P_{DC} = \eta_{ext\ losses} \left\{ P_{peak} \cdot \left( \frac{G_{eff}}{G^*} \right) \cdot [1 - \beta(T_c - T^{*c})] \right\} \quad (1)$$

Where,  $\eta_{ext\ losses}$  are losses for modules mismatching, diodes and dirt (9%);

$P_{peak}$  = the rated power of one module (W)

$G_{eff}$  = the effective global radiation (W/m<sup>2</sup>)

$G^*$  = the radiation in standard conditions (1000W/m<sup>2</sup>)

$\beta$  = the temperature losses coefficient (0.005/°C)

$T_c$  = the operation cell temperature

$T^{*c}$  = the standard operation cell temperature (25°C)

The operation temperature  $T_c$  is calculated as follows:

$$T_c = T_{amb} (NOCT - TNOCT, std) \cdot \left( \frac{G_{eff}}{GNOCT} \right) \quad (2)$$

Where

$T_{amb}$  = the ambient temperature (°C)

$NOCT$  = the nominal operation cell temperature (47°C)

$TNOCT, std$  = the ambient temperature at NOCT conditions (20°C)

$GNOCT$  = the radiation at  $NOCT$  conditions (800 W/m<sup>2</sup>)

In Figure 1, Equations (1) and (2) were developed into a MATLAB model using SIMULINK. This was done to ease computation and analysis of results. The expected inputs to the model are solar irradiance and temperature.

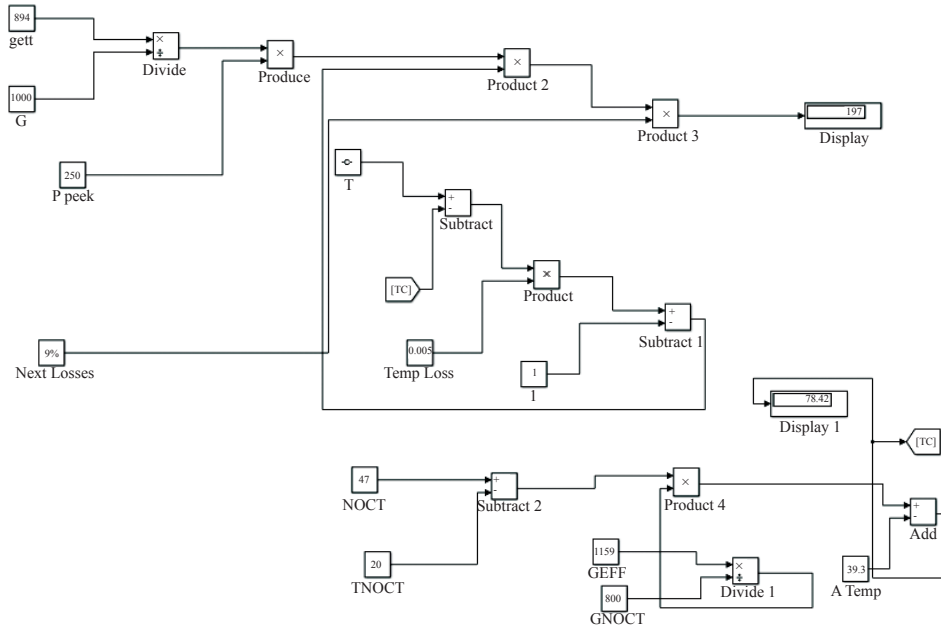

Figure 1: Simulink Analytical Model.



Figure 2: Array of Solar Panels where data was captured.

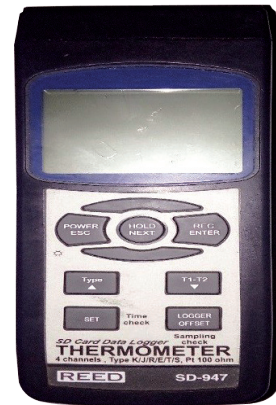

Figure 3: REED SD-947 Thermometer used for the temperature data capture.

### 3 Data Collection

The location of study is the Department of Computer and Electrical Engineering, Olabisi Onabanjo University, Ogun State situated in the South-West zone of Nigeria. The measurement site is shown in Figure 2. The inputs to the described model in section 2 are irradiance and temperature. To obtain the two parameters, a thermometer and a pyranometer is used. Hourly readings were taken between the hours of 9 am to 4 pm for 30 days. The 30 days period was selected because it represents a period of the year without rainfall (dry season). The

REED SD-947 thermometer shown in Figure 3 was used to measure the ambient temperature around the panels. The 4-Channel meter has a measuring range of 0–50°C with an accuracy of  $\pm 0.8^\circ\text{C}$ . Figure 5 shows the graph of the average measured daily temperature over a 30 day period.

The Dr. Meter SM206 solar meter is a precision instrument for measurement of solar radiation. It has an operating range of 1–3999  $\text{w}/\text{m}^2$  with an accuracy of  $\pm 5\%$ . This device, shown in Figure 4, was used to



**Figure 4:** Dr Meter SM206 Solar Power Meter used for the Irradiance data capture.

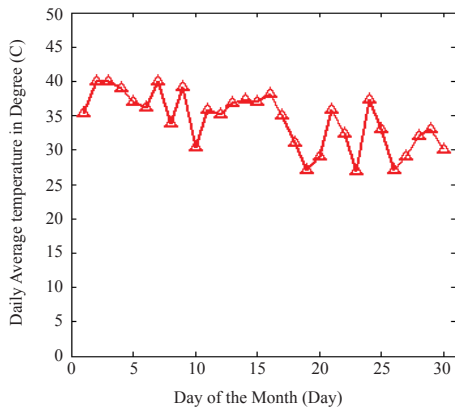

**Figure 5:** Average daily temperature for 30 days.



**Figure 6:** ET6415 BND charge controller.

measure the irradiance on the solar panels while the power output of the PV plant was also monitored at an hour interval using the ET6415 BND solar charge controller shown in Figure 6. The two sets of data were recorded directly into a Microsoft excel program worksheet. The collected temperature and irradiance data were then fed into the mathematical model described in section 2. The power outputs from the model and the charge controller were compared using

three statistical test tools and the conclusion was drawn based on the observations.

### 3.1 Methods

To compare the two outputs, three statistical test tools were used. They include Mean Bias Error (MBE), Root Mean Square Error (RMSE) and Mean Absolute Percentage Error (MAPE). The Mean Bias Error (MBE) provides information on the long-term performance of the correlations by allowing a comparison of the actual deviation between simulated and measured values term by term. The ideal value of the MBE

$$MBE = \sum_{k=1}^n \frac{1}{n} (y_k - x_k) \quad (3)$$

Where,

$y_k$  = kth simulated value

$x_k$  = kth measured value

$n$  = total number of days

The Root-Mean-Square Error (RMSE) is another used measure of the differences between predicted values of a model or an estimator and the values observed from the thing being modelled or estimated. RMSE is a good measure of precision and provides information on the short-term performance of a model. The value of RMSE is always positive, representing zero in the ideal case. A low RMSE is however desirable.

The RMSE may be computed from the following Equations (4) and (5):

$$RMSE = \sqrt{\frac{1}{n} \sum_{k=1}^n \left( \frac{y_k - x_k}{x_k} \right)^2} \quad (4)$$

$$\%Relative\ Error\ (\%RE) = \left| 1 - \left( \frac{y_k}{x_k} \right) \right| * 100 \quad (5)$$

The Mean Absolute Percentage Error (MAPE) value provides the percentage deviation between the calculated and measured data while the relative error is the absolute error divided by the magnitude of the exact value. The ideal value of MAPE is zero.

## 4 Results and Discussions

To evaluate the accuracy of the analytical model described in section 2, two sets of results were obtained

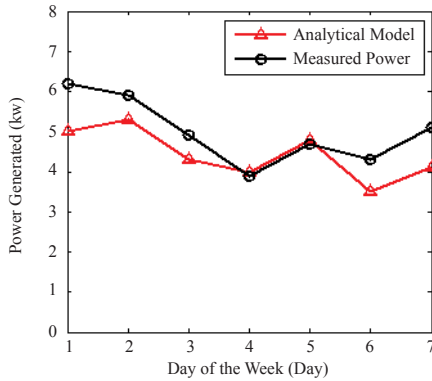

Figure 7: Average daily power output for week 1.

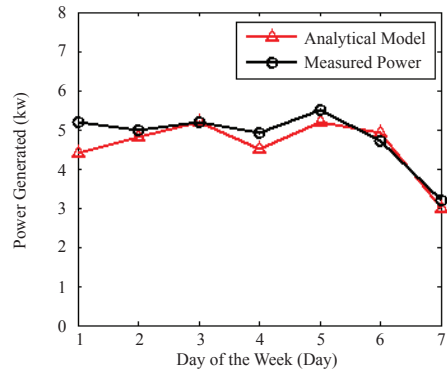

Figure 9: Average daily power output for week 3.

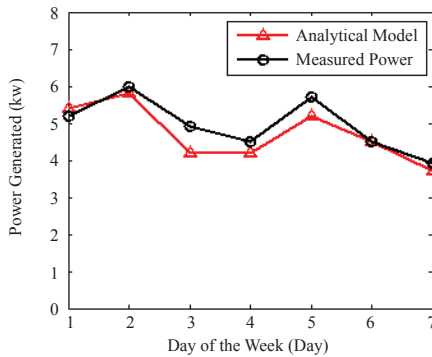

Figure 8: Average daily power output for week 2.

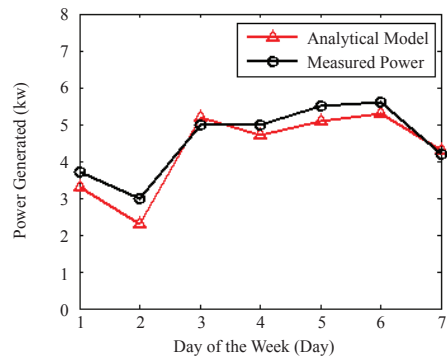

Figure 10: Average daily power output for week 1.

for a 30 day period. The first set was from the simulated analytical model while the second set was the direct measurement of the power output as recorded by the ET6415 BND Charge Controller which represents the actual power output of the mini PV plant. The results from the analytical model are compared with the measured result from the mini PV plant. For brevity, the recorded hourly power outputs were averaged and is presented daily in Figures 7–10.

Figure 7 shows the graph of the average daily power output for week 1. The graph reveals a good performance of the analytical model for day 4 and 5 with a power output equivalent to the measured power. For other days, slight variations were observed. Similar trend was observed in Figure 8 (week 2) where days 1, 2, 6 and 7 had similar values while little variations were observed for days 2 to 5. In Figure 9 (week 3), days 3, 6 and 7 also had similar values while other days recorded slight variations. In Figure 10 (week 4),

days 3 and 7 had equivalent power output values while degrees of variations were observed for other days in the week. Generally, from Figures 7–10, it can be observed that the analytical model consistently underestimated the power output of the PV panels because its estimated values were lower than the measured power for the reporting period. For Figures 7–10, the MBE, RMSE and MAPE values for the analytical model were evaluated using Equations (3), (4) and (5) and the results are shown in Table 1.

Table 1: Summary of Results

	MBE	RMSE	MAPE	%RE
Week 1	0.22	0.32	0.25	6
Week 2	0.18	0.30	0.23	5.7
Week 3	0.17	0.29	0.22	5
Week 4	0.17	0.29	0.22	5

From the result shown in Table 1, the MBE values of the simulated model for the four weeks are seen to be lower than 0.3 which signifies a good performance. In terms of the RMSE, the values recorded for the four weeks are 0.32, 0.30, 0.29 and 0.29 respectively. The MAPE values are 0.25, 0.23, 0.22 and 0.22. The implication of this set of results is the good performance of the simulated model. This further reveal that the model describes the relationship between the three parameters (solar irradiance, temperature, and power output) relatively well. Another implication of this result is that the model can be modified to produce a more accurate result that would be reflected in a lower MAPE, MBE, and RMSE values.

## 5 Conclusions

This paper carries out an empirical study on the effect of temperature and irradiance on the power output of a PV plant situated in Nigeria. To achieve this, hourly temperature and irradiance data were collected and inputted into a simulated analytical model. The model describes the relationship between temperature, irradiance and the power output of a PV cell. The input to the model are temperature and irradiance. Power output from the PV plant was also recorded within the period. Power output from the model was then compared with the directly measured power from the plant using three statistical tools of MBE, RMSE, and MAPE. Results obtained revealed that the model describes the relationship between the three parameters (solar irradiance, temperature, and power output) relatively well. Results from this work has shown that the analytical model can be reliably used in PV plant power output forecasting when the temperature and irradiance data have been known or acquired via weather prediction techniques.

## Acknowledgments

We appreciate the effort of Mr. George Adekoya and Mr. Ogunkeye, our technologists, for coordinating the data collection process and ensuring the process went on smoothly.

## References

- [1] O. Ellabban, H. Abu-Rub, and F. Blaabjerg, "Renewable energy resources: Current status, future prospects, and their enabling technology," *Renewable and Sustainable Energy Reviews*, vol. 39, pp. 748–764, 2014.
- [2] A. Giwa, A. Alabi, A. Yusuf, and T. Olukan, "A comprehensive review on biomass and solar energy for sustainable energy generation in Nigeria," *Renewable and Sustainable Energy Reviews*, vol. 69, pp. 620–641, 2017.
- [3] B. V. Chikate and Y. A. Sadawarte, "The factors affecting the performance of solar cell," in *Proceedings International Conference on Quality Up-gradation in Engineering, Science and Technology (ICQUEST2015)*, 2015, pp. 1–5.
- [4] A. G. Gaglia, S. Lykoudis, A. A. Argiriou, C. A. Balaras, and E. Dialynas, "Energy efficiency of PV panels under real outdoor conditions—An experimental assessment in Athens, Greece," *Renewable Energy*, vol. 101, pp. 236–243, 2017.
- [5] M. Theelen, A. Liakopoulou, V. Hans, F. Daume, H. Steijvers, N. Barreau, Z. Vroon, and M. Zeman, "Determination of the temperature dependency of the electrical parameters of CIGS solar cells," *Journal of Renewable and Sustainable Energy*, vol. 9, no. 2, pp. 021205, 2017.
- [6] K. Tvingstedt and C. Deibel, "Temperature dependence of ideality factors in organic solar cells and the relation to radiative efficiency," *Advanced Energy Materials*, vol. 6, no. 9, 2016.
- [7] K. L. Osanyinpeju, A. A. Aderinlewo, O. R. Adetunji, and E. S. Ajisegiri, "Performance evaluation of mono-crystalline photovoltaic panels in Funaab, Alabata, Ogun State, Nigeria weather condition," *Performance Evaluation*, vol. 5, no. 2, pp. 8–20, 2018.
- [8] O. Perpignan, E. Lorenzo, and M. A. Castro, "On the calculation of energy produced by a PV grid-connected system," *Progress in Photovoltaics: Research and Applications*, vol. 15, no. 3, pp. 265–274, 2007.
- [9] C. Xiao, X. Yu, D. Yang, and D. Que, "Impact of solar irradiance intensity and temperature on the performance of compensated crystalline silicon solar cells," *Solar Energy Materials and Solar Cells*, vol. 128, pp. 427–434, 2014.
- [10] A. Mahfoud, S. Mekhilef, and F. Djahli, "Effect of temperature on the GaInP/GaAs tandem solar cell performances," *International Journal of Renewable Energy Research (IJRER)*, vol. 5, no. 2,

- pp. 629–634, 2015.
- [11] S. Chander, A. Purohit, A. Sharma, S. P. Nehra, and M. S. Dhaka, “A study on photovoltaic parameters of mono-crystalline silicon solar cell with cell temperature” *Energy Reports*, vol. 1, pp. 104–109, 2015.
- [12] A. Q. Malik, L. C. Ming, T. K. Sheng, and M. Blundell, “Influence of temperature on the performance of photovoltaic polycrystalline silicon module in the Bruneian climate,” *ASEAN Journal on Science and Technology for Development*, vol. 26, no. 2, pp. 61–72, 2017.
- [13] S. Garg and J. B. Arun, “High temperature effect on multicrystalline photovoltaic module in Western Rajasthan, India,” *High Temperature*, vol. 4, no. 2, pp. 44–48, 2016.